

hergam



Glance & Glance L



Dimensions, Specifications and Clearances

GLANCE

704 Width x 410 Depth x 590 Height

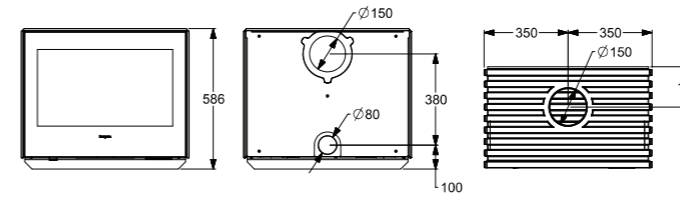

GLANCE L

704 Width x 410 Depth x 820 Height

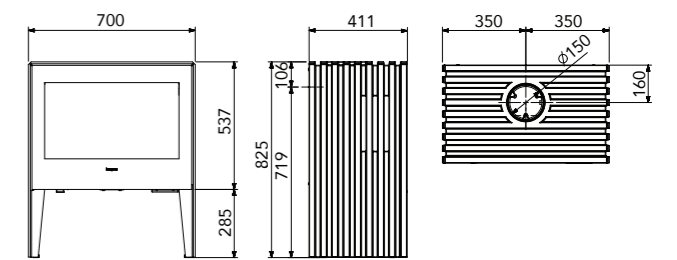

All measurements are to the combustible material

	A	B	C	D	E	F	G	H	I	J
No Shielding	560	750	400	400	1260	970	450	510	150	1422
Firebox Heatshield	460	825	475	300	1160	970	450	N/A	N/A	N/A
Firebox Heatshield + ** Flue Shield	335	825	475	175	1035	970	450	N/A	N/A	N/A

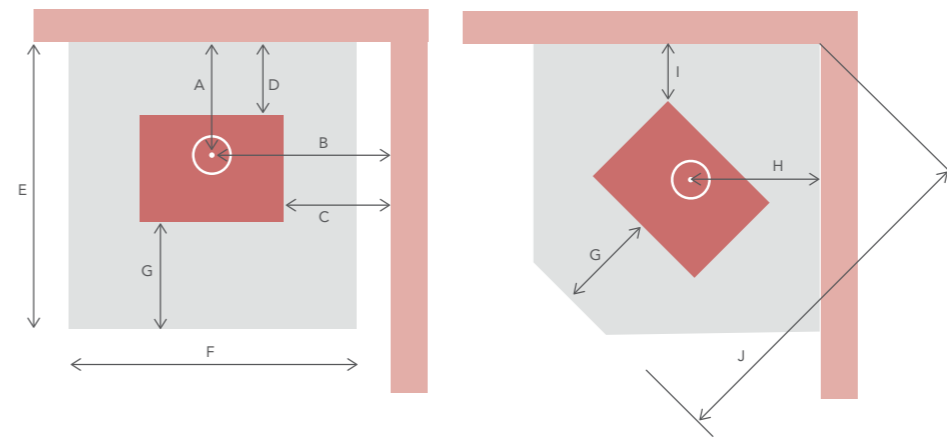

Tested Configuration

- 18mm cement sheet
- 6" active / 8" solid
- ** 6" active / 900mm inner flue shield / 8" solid
- Firebox Heatshield

Glance L

Hailing from Copenhagen Design Studio Strand and Haas, the Hergom Glance range creates a strong focal point in any room. The large landscape firebox is further enhanced with glass sides so you get an even greater view of this exceptional fire.

Hergom scooped up first place at the Hearth & Home Exhibition in the 'Best Stove Over 5kW' category.

Heat Capacity	15 sq
Peak Efficiency	63%
Emissions	1.2
Max. log length	400mm
Weight	Glance 185kg / Glance L 195kg

Glass hearth pictured in this brochure is not available in Australia.

Key Features

- ✓ Award winning Danish design
- ✓ Glance bench option
- ✓ Vermiculite interior radiates heat
- ✓ 180 degree view of flames
- ✓ Large landscape firebox
- ✓ Streamline integrated push close door





E-30

The E30 shares the same firebox as the E40 and therefore the same key features and advantages of these magnificent fires. Constructed entirely from a robust cast iron and with the latest combustion technology, the E-30 M is a sustainable heating solution that produces a powerful 10.6kW of heat output. A large loading capacity, and a clean burn system guarantee an efficient longer lasting burn.

Key Features

- ✓ Traditional design on solid cast iron legs
- ✓ White cast iron liners
- ✓ Cast Iron radiant heat
- ✓ Large glass viewing area

Heat Capacity	15 - 18 sq
Peak Efficiency	67%
Emissions	1.5
Max. log length	400mm
Weight	150kg

Dimensions, Specifications and Clearances

660 Width x 540 Depth x 740 Height

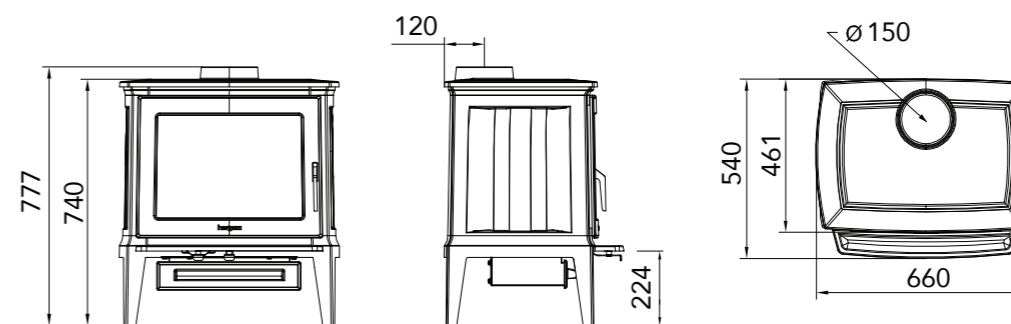

All measurements are to the combustible material

	A	B	C	D	E	F	G	H	I	J
Firebox Heatshield + Flue Shield	327	830	500	200	1040	830	300	648	325	1630

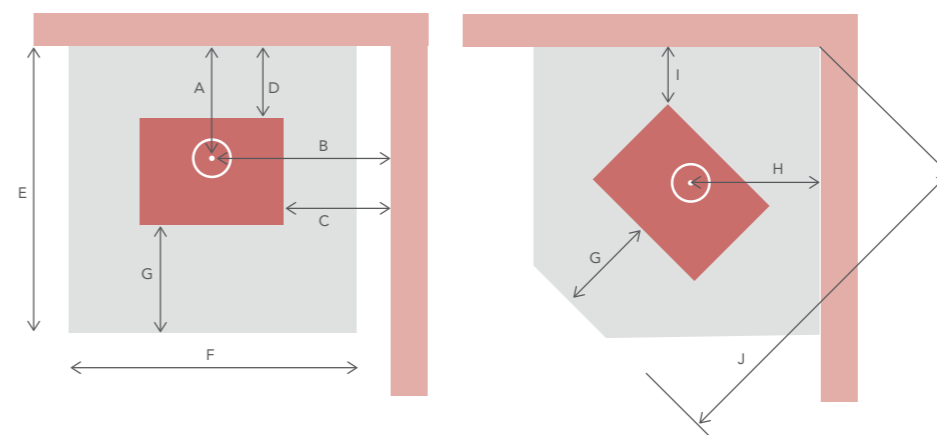

Tested Configuration

- 12mm cement sheet
- 6" active / 900mm inner flue shield / 8" solid
- Firebox Heatshield

Glass hearth pictured in this brochure is not available in Australia.



E-40

The contemporary design of the E-40 incorporates smooth edges that compliment the fluidity of the flames visible through the large, glass front. The E-40 provides a constant, gentle warmth due to the heat retention properties of its robust, cast iron construction. The cast iron internal plates of the combustion chamber and the white coating reflects more heat into the room as well as highlighting the brilliance of the fire as never before.

Heat Capacity	15-18sq
Peak Efficiency	67%
Emissions	1.5
Max. log length	400mm
Weight	150kg

Key Features

- ✓ White cast iron liners
- ✓ Clean contemporary design
- ✓ Cast Iron radiant heat
- ✓ Large glass viewing area

Dimensions, Specifications and Clearances

600 Width x 430 Depth x 870 Height

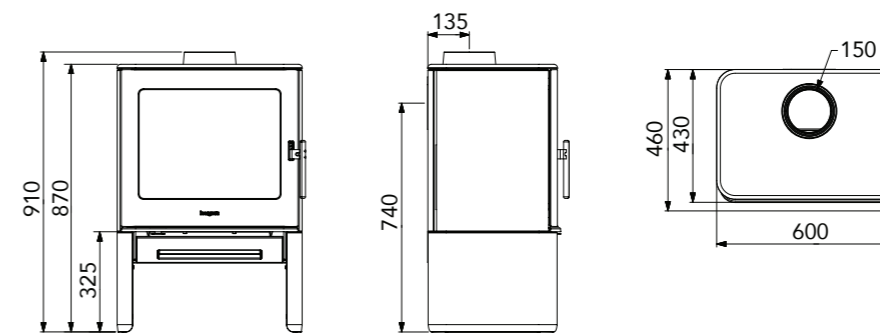

All measurements are to the combustible material

	A	B	C	D	E	F	G	H	I	J
Firebox Heatshield + Solid Flue Shield	412	800	500	275	1025	860	320	609	300	1474

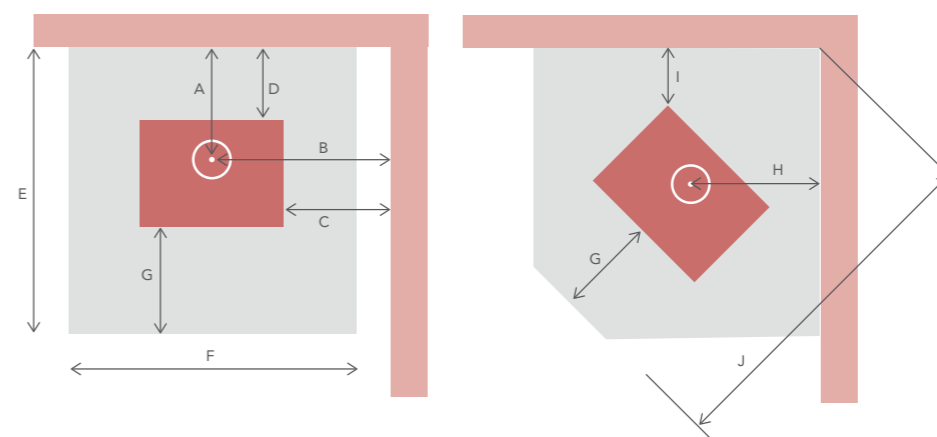

Tested Configuration

- 9mm cement sheet
- 6" active / 8" solid
- Firebox Heatshield

Glass hearth pictured in this brochure is not available in Australia.

Introducing Hergom's newest addition, The Cast Iron Firepit

No more cold nights with this wood burning outdoor grill. Warm up next to the fire or, grill up some food with friends on one of the cooking rings, and take advantage of the unique taste and beneficial qualities of cast iron cooking.



For over 50-years, Hergóm has been producing efficient, sustainable and technically-advanced fireplaces and cookers from a state-of-the art foundry in Santander. Their wood-stoves are among the cleanest burning in the world providing maximum heat and fuel performance with minimal emissions. The finest cast iron is used as the primary material in their production. Hergom have a deep knowledge and understanding of cast iron and its resilience.

Your Hergom dealer

castworks
home heating specialists

DISTRIBUTORS
FOR



MADE IN SPAIN

The information contained in this brochure is to assist you in your choice of a suitable fire. It is not intended to be all the information required to install the fire and does not replace the installation manual which provides more detailed information. In the interest of product development Hergom reserves the right to change specifications without prior notice.

castworks.com.au